

VISUAL

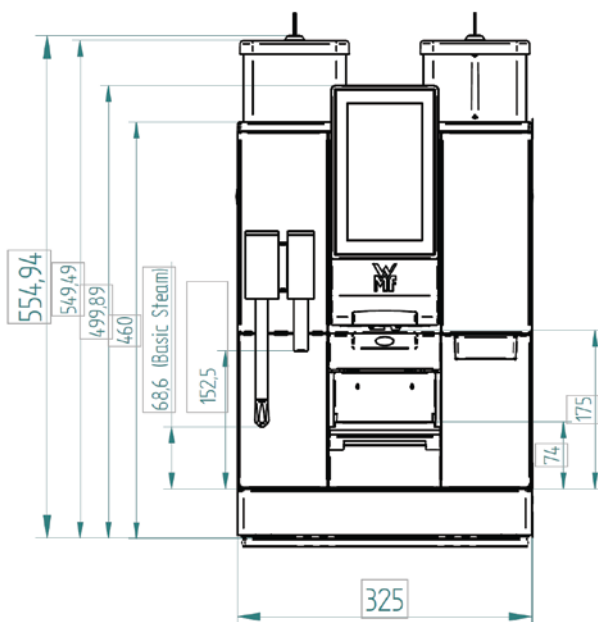

FRONT



SIDE

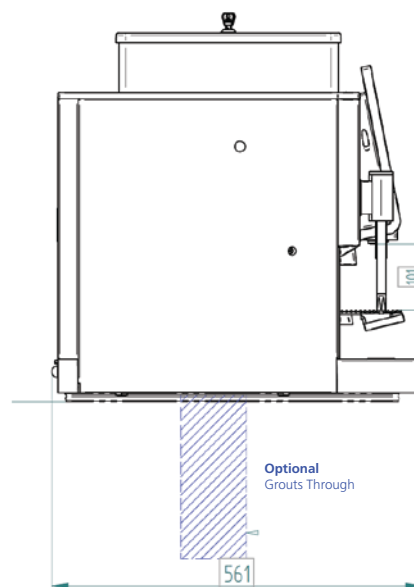

TOP

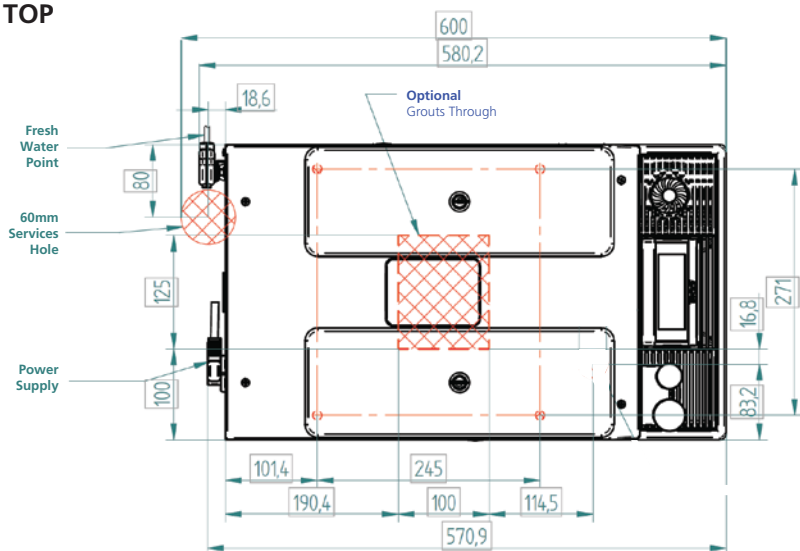

SPECIFICATIONS

Nominal power rating	1.9 - 2.3 kW
Recommended daily output*	Up to 80 cups
Max. hourly output**	Up to 70 cups
Coffee bean hopper(s)	550 g (with ext. 1100g)
Choc or topping container	450 g (with ext. 1250g)
Mains power connection	230 V, 10amp, Single phase
Water connection	3/8" Hose. Min 0.2 MPa @ 2L / m, Max 0.6 MPa
Dimensions (width / height / depth)	325 mm / 500 mm / 561 mm
Empty weight, depending on fittings	Approx. 25.5 kg
Continuous sound pressure level (LpA)***	< 70 dB (A)

* Based on the relevant service concept. These average values are for your information only. – Let our trained WMF employees put together a coffee machine solution that is designed to meet your needs.

** Depending on cup size, quality settings and flow.

*** The A-rated sound pressure level LpA (slow) and LpA (impulse) at the workplace of the staff using the machine is less than 70 dB (A) in every mode. From 5° dKH (carbonate hardness), a WMF water filter must be used. All technical changes, typographical mistakes and errors reserved for the entire contents.

CONDITIONS FOR USAGE AND INSTALLATION

Necessary on-site preparatory work for electricity, water and drainage connections at the customer’s premises are to be arranged by the machine owner / operator. The work must be carried out by authorised installation technicians in compliance with general, country-specific and local regulations. The WMF service engineers may only connect the coffee machine to existing prepared connection points. WMF Service is neither authorised nor responsible for carrying out any on-site installation work prior to connection.

Mains voltage tolerance range	230 V +6 % and–10 %. Mains voltage interruption < 50 ms: no interruption of function
Water supply	3/8 inch hose connector with mains tap, and filter with 0.2 to 0.25 mm mesh size, on site and within 1m from machine. At least 0.3 MPa (3 bar) flow pressure at 2 L/min (standard). Maximum 0.6 MPa (6 bar). Maximum inlet temp 35 °C. The set of hoses provided with the new coffee machine and/or the new water filter must be used. Do not use old hoses.
Water quality	BWT Water filtration (or equiv). Ideal water quality is; TDS 120ppm, PH Level 7.0, Carbonate hardness below 5 °dKH.
Water drain tube (Plumbed)	Tube a minimum of DN 19, minimum downward slope of 2 cm/m
Ambient temperature	+5 °C to +35 °C
Maximum humidity	80% relative humidity without condensation. Do not use device outdoors.
Degree of protection	IP X0
Installation surface / water spray	The device must be placed and leveled on a horizontal, sturdy, water-resistant, and heatproof base. The device must not be cleaned using a water jet. The device must be installed where it is protected against water spray. The device must not be located on a surface that is sprayed or cleaned with a water hose, steam jets, steam cleaner, or similar devices.